

BUZON PB-Serie® Plots réglables de 28 à 965mm



© COPYRIGHT

BUZON Pedestal International s.a./n.v
Z.I. des Hauts-Sarts, Zone 1 - Prolongement de la rue de l'Abbaye, 134 , B-4040 Herstal- Belgium
Tel +32(0)4 248 39 83 Fax +32(0)4 264 82 38 E-Mail info@buzon.eu

www.buzon.eu

BUZON® PB-Serie

Applications

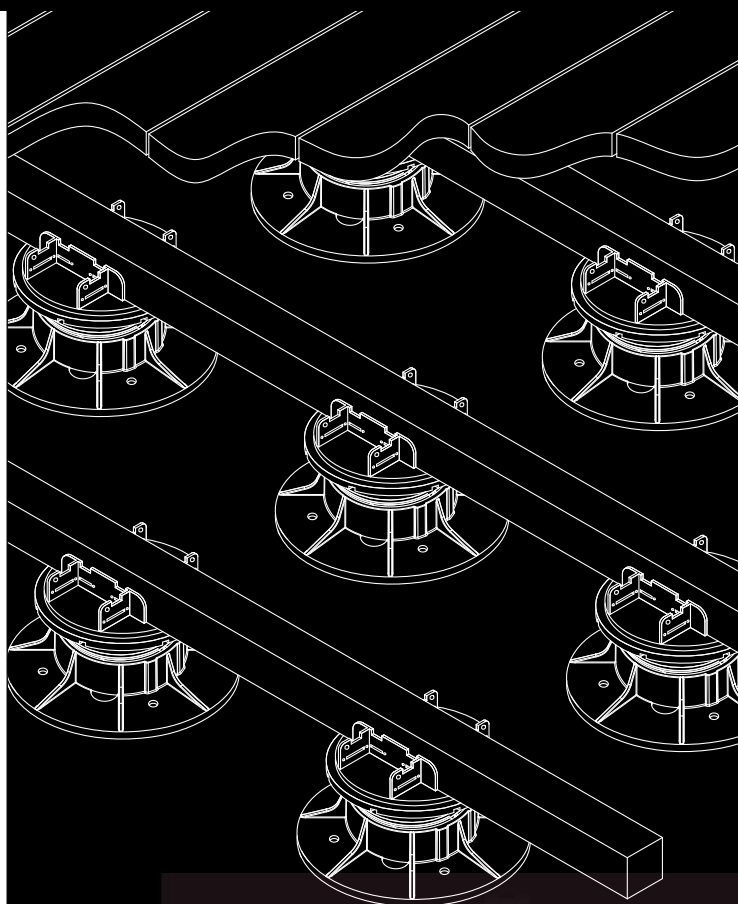
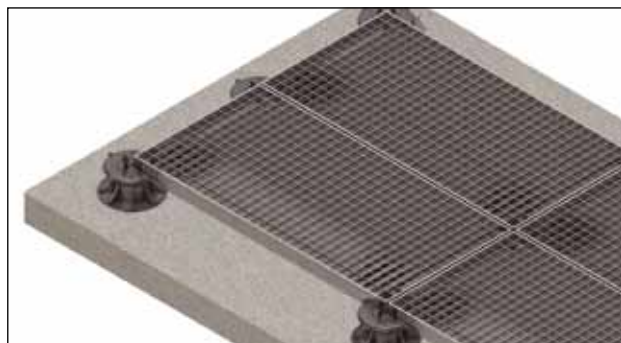

Sur simple demande*, notre département conception met à la disposition des architectes et bureaux d'études, des fichiers en 2D. Ceux-ci sont compatibles avec les principaux logiciels d'architecture et permettent ainsi l'intégration des plots Buzon dans les plans.

* Texte de cahier des charges sur demande.



BUZON® PB-Serie

Les plots **PB-Serie BUZON** se caractérisent par leur tête universelle capable de supporter tous types de lambourdes et dalles grâce aux Kits d'accessoires spécialement étudiés



ACCESSOIRES

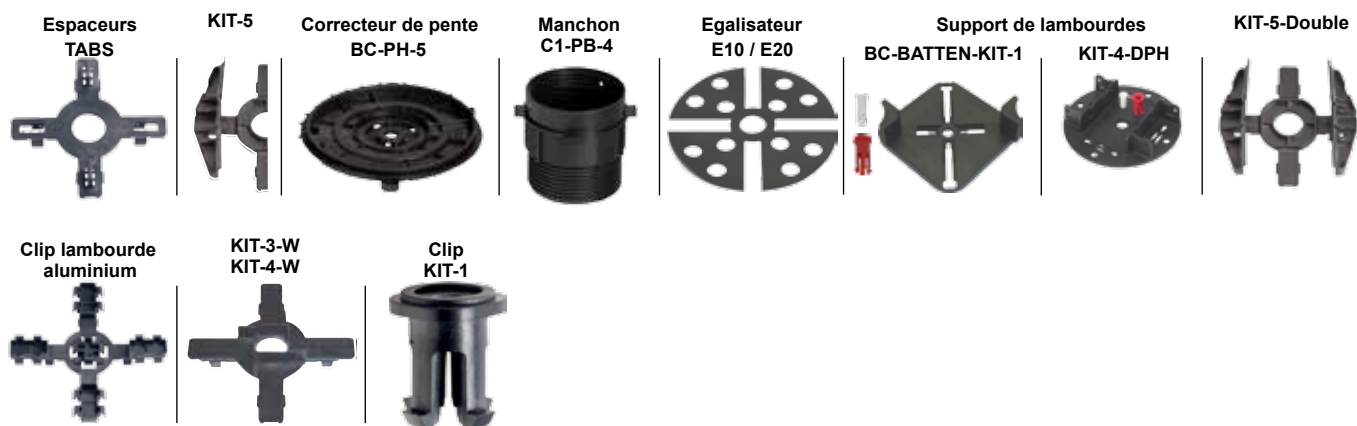

BUZON PB-Serie®

Vente à l'unité ou par carton complet

Code	Hauteur
PB-01	28-42mm

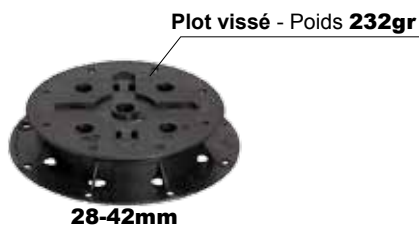

Qté pces/carton
84



Dim. carton: **60x40x42cm**
 Poids carton seul: **1120gr**
 Poids carton + pièces: **22kg**

Qté cartons/palette	Qté pces/palette
25	2100



Poids brut: **565kg**
 Poids net: **522kg**
 Dim. palette: **100x120x224cm**
 Poids palette vide: **15kg 100X120X15cm**

Code	Hauteur
PB-1	42-60mm



Qté pces/carton
54



Dim. carton: **60x40x42cm**
 Poids carton seul: **1120gr**
 Poids carton + pièces: **18kg**

Qté cartons/palette	Qté pces/palette
25	1350



Poids brut: **465kg**
 Poids net: **417kg**
 Dim. palette: **100x120x224cm**
 Poids palette vide: **15kg 100X120X15cm**

Code	Hauteur
PB-2	60-90mm

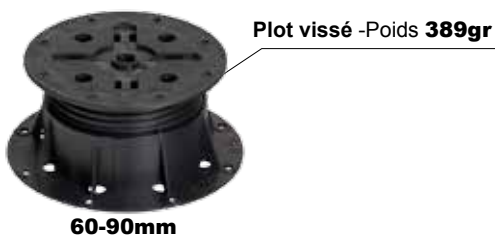

Qté pces/carton
36



Dim. carton: **60x40x37cm**
 Poids carton seul: **996gr**
 Poids carton + pièces: **15kg**

Qté cartons/palette	Qté pces/palette
25	900



Poids brut: **390kg**
 Poids net: **350kg**
 Dim. palette: **100x120x200cm**
 Poids palette vide: **15kg 100X120X15cm**

Code	Hauteur
PB-3	90-145mm



Qté pces/carton
24



Dim. carton: **60x40x37cm**
 Poids carton seul: **996gr**
 Poids carton + pièces: **13kg**

Qté cartons/palette	Qté pces/palette
25	600



Poids brut: **340kg**
 Poids net: **295kg**
 Dim. palette: **100x120x200cm**
 Poids palette vide: **15kg 100X120X15cm**

Code	Hauteur
PB-4	145-245mm



Qté pces/carton
24



Dim. carton: **60x40x60cm**
 Poids carton seul: **1440gr**
 Poids carton + pièces: **18kg**

Qté cartons/palette	Qté pces/palette
15	360



Poids brut: **285kg**
 Poids net: **248kg**
 Dim. palette: **100x120x200cm**
 Poids palette vide: **15kg 100X120X15cm**

BUZON PB-Serie®

Vente à l'unité ou par carton complet

Code
PB-3-BASE



Qté pces/carton
24



Dim. carton: **60x40x37cm**
Poids carton seul: **996gr**
Poids carton + pièces: **7kg**

Qté cartons/palette
25

Qté pces/palette
600



Poids brut: **190kg**
Poids net: **145kg**
Dim. palette: **100x120x200cm**
Poids palette vide: **15kg 100X120X15cm**

Code
PB-3-TOP

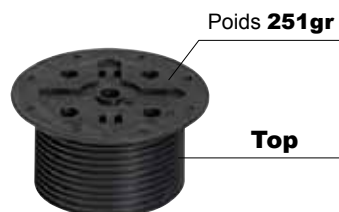

Qté pces/carton
24



Dim. carton: **60x40x37cm**
Poids carton seul: **996gr**
Poids carton + pièces: **8kg**

Qté cartons/palette
25

Qté pces/palette
600



Poids brut: **215kg**
Poids net: **151kg**
Dim. palette: **100x120x200cm**
Poids palette vide: **15kg 100X120X15cm**

Code
PB-4-BASE



Qté pces/carton
24



Dim. carton: **60x40x44cm**
Poids carton seul: **1120gr**
Poids carton + pièces: **10kg**

Qté cartons/palette
25

Qté pces/palette
600



Poids brut: **265kg**
Poids net: **217kg**
Dim. palette: **100x120x240cm**
Poids palette vide: **15kg 100X120X15cm**

Code
PB-4-TOP



Qté pces/carton
24



Dim. carton: **60x40x44cm**
Poids carton seul: **1120gr**
Poids carton + pièces: **9kg**

Qté cartons/palette
25

Qté pces/palette
600



Poids brut: **240kg**
Poids net: **197kg**
Dim. palette: **100x120x240cm**
Poids palette vide: **15kg 100X120X15cm**

Code
C1-PB-4



Qté pces/carton
24

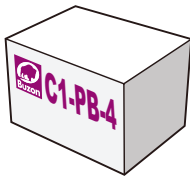

Dim. carton: **60x40x44cm**
Poids carton seul: **1120gr**
Poids carton + pièces: **8kg**

Qté cartons/palette
25

Qté pces/palette
600



Poids brut: **215kg**
Poids net: **168kg**
Dim. palette: **100x120x240cm**
Poids palette vide: **15kg 100X120X15cm**



BUZON PB-Serie®

Vente à l'unité ou par carton complet

Code	Hauteur
PB-5-NSC	230-315mm



230-315mm Poids 892gr



PB3-TOP
1 carton X 24 pces



C1-PB-4
1 carton X 24 pces



PB-4-BASE
1 carton X 24 pces

NSC = Plot non vissé

Qté pces/carton
24

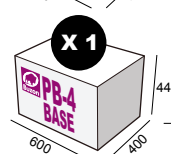

Caractéristiques carton et palette voir p.5: **PB-3-TOP**



Qté cartons/palette	25
Qté pces/palette	600

Caractéristiques carton et palette voir p.5: **C1-PB-4**



Qté cartons/palette	25
Qté pces/palette	600

Caractéristiques carton et palette voir p.5: **PB-4-BASE**



Qté cartons/palette	25
Qté pces/palette	600

Remarque: La palette de PB5-NSC peut être composée de boîtes d'articles différents.

Code	Hauteur
PB-6-NSC	285-367mm



285-367mm Poids 970gr



PB4-TOP
1 carton X 24 pces



C1-PB-4
1 carton X 24 pces



PB-4-BASE
1 carton X 24 pces

NSC = Plot non vissé

Qté pces/carton
24

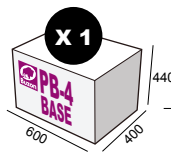
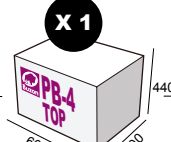

Caractéristiques carton et palette voir p.5: **PB-4-TOP**



Qté cartons/palette	25
Qté pces/palette	600

Caractéristiques carton et palette voir p.5: **C1-PB-4**



Qté cartons/palette	25
Qté pces/palette	600

Caractéristiques carton et palette voir p.5: **PB-4-BASE**



Qté cartons/palette	25
Qté pces/palette	600

Remarque: La palette de PB-6 peut être composée de boîtes d'articles différents.

Code	Hauteur
PB-7-NSC	365-485mm



365-485mm Poids 1250gr



PB4-TOP
1 carton X 24 pces



X 2

C1-PB-4
2 cartons X 24 pces



PB-4-BASE
1 carton X 24 pces

NSC = Plot non vissé

Qté pces/carton
24

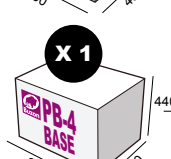
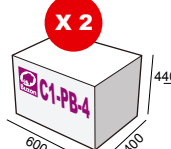
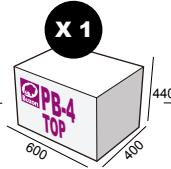

Caractéristiques carton et palette: voir page 5: **PB-4-TOP**



Qté cartons/palette	25
Qté pces/palette	600

Caractéristiques carton et palette: voir page 5: **C1-PB-4**



Qté cartons/palette	25
Qté pces/palette	600

Caractéristiques carton et palette: voir page 5: **PB-4-BASE**



Qté cartons/palette	25
Qté pces/palette	600

Remarque: La palette de PB-7 peut être composée de boîtes d'articles différents.



BUZON PB-Serie®

Vente à l'unité ou par carton complet

Code	Hauteur	Qté pces/carton	Caractéristiques carton et palette: voir page 5: PB-4-TOP				
PB-8-NSC	452-605mm	24	<table border="1"> <tr><td>Qté cartons/palette</td><td>25</td></tr> <tr><td>Qté pces/palette</td><td>600</td></tr> </table>	Qté cartons/palette	25	Qté pces/palette	600
Qté cartons/palette	25						
Qté pces/palette	600						
		X 1	<table border="1"> <tr><td>Qté cartons/palette</td><td>25</td></tr> <tr><td>Qté pces/palette</td><td>600</td></tr> </table>	Qté cartons/palette	25	Qté pces/palette	600
Qté cartons/palette	25						
Qté pces/palette	600						
		X 3	<table border="1"> <tr><td>Qté cartons/palette</td><td>25</td></tr> <tr><td>Qté pces/palette</td><td>600</td></tr> </table>	Qté cartons/palette	25	Qté pces/palette	600
Qté cartons/palette	25						
Qté pces/palette	600						
		X 1	<table border="1"> <tr><td>Qté cartons/palette</td><td>25</td></tr> <tr><td>Qté pces/palette</td><td>600</td></tr> </table>	Qté cartons/palette	25	Qté pces/palette	600
Qté cartons/palette	25						
Qté pces/palette	600						

452-605mm Poids 1530gr **NSC =Plot non vissé** **Remarque: La palette de PB-8 peut être composée de boîtes d'articles différents.**

Code	Hauteur	Qté pces/carton	Caractéristiques carton et palette: voir page 5: PB-4-TOP				
PB-9-NSC	537-725mm	24	<table border="1"> <tr><td>Qté cartons/palette</td><td>25</td></tr> <tr><td>Qté pces/palette</td><td>600</td></tr> </table>	Qté cartons/palette	25	Qté pces/palette	600
Qté cartons/palette	25						
Qté pces/palette	600						
		X 1	<table border="1"> <tr><td>Qté cartons/palette</td><td>25</td></tr> <tr><td>Qté pces/palette</td><td>600</td></tr> </table>	Qté cartons/palette	25	Qté pces/palette	600
Qté cartons/palette	25						
Qté pces/palette	600						
		X 4	<table border="1"> <tr><td>Qté cartons/palette</td><td>25</td></tr> <tr><td>Qté pces/palette</td><td>600</td></tr> </table>	Qté cartons/palette	25	Qté pces/palette	600
Qté cartons/palette	25						
Qté pces/palette	600						
		X 1	<table border="1"> <tr><td>Qté cartons/palette</td><td>25</td></tr> <tr><td>Qté pces/palette</td><td>600</td></tr> </table>	Qté cartons/palette	25	Qté pces/palette	600
Qté cartons/palette	25						
Qté pces/palette	600						

537-725mm Poids 1810gr **NSC = Plot non vissé** **Remarque: La palette de PB-9 peut être composée de boîtes d'articles différents.**



BUZON PB-Serie®

Vente à l'unité ou par carton complet

Code	Hauteur
PB-10-NSC	620-845mm

Qté pces/carton
24

Caractéristiques carton et palette:
voir page 5: **PB-4-TOP**

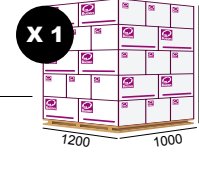
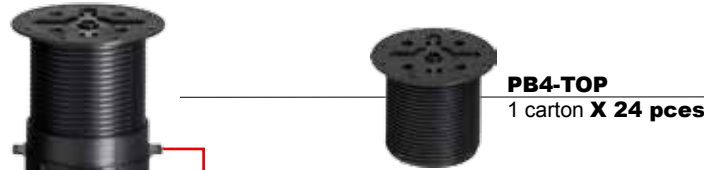

Qté cartons/palette	25
Qté pces/palette	600

C1-PB-4 5 cartons X24 pces

Caractéristiques carton et palette:
voir page 5: **C1-PB-4**

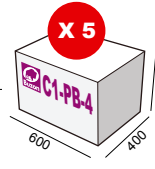

Qté cartons/palette	25
Qté pces/palette	600

PB-4-BASE
1 carton X 24 pces

Caractéristiques carton et palette:
voir page 5: **PB-4-BASE**

620-845mm
Poids **2090gr**

NSC = Plot non vissé

Remarque: La palette de PB-10 peut être composée de boîtes d'articles différents.

Code	Hauteur
PB-11-NSC	705-965mm

Qté pces/carton
24

Caractéristiques carton et palette:
voir page 5: **PB-4-TOP**

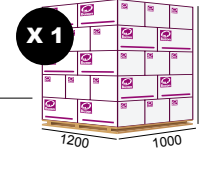
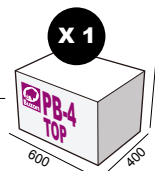

Qté cartons/palette	25
Qté pces/palette	600

C1-PB-4 6 cartons X24 pces

Caractéristiques carton et palette:
voir page 5: **C1-PB-4**



Qté cartons/palette	25
Qté pces/palette	600

PB-4-BASE
1 carton X 24 pces

Caractéristiques carton et palette:
voir page 5: **PB-4-BASE**

705-965mm
Poids **2370gr**

NSC =Plot non vissé

Remarque: La palette de PB-11 peut être composée de boîtes d'articles différents.



BUZON® PB-Serie

Accessoires

Vente à l'unité ou par carton complet

Code	Largeur ailettes
PB-TABS-2	2mm
PB-TABS-4.5	4.5mm

Qté pces/carton
120
120

Ailettes pour support dalles

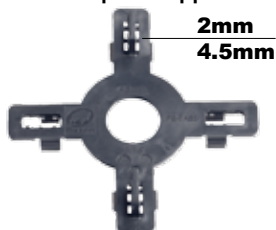

Poids 2mm **16g** / 4.5mm **17g**

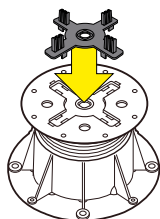

Hauteur ailettes: **17mm**

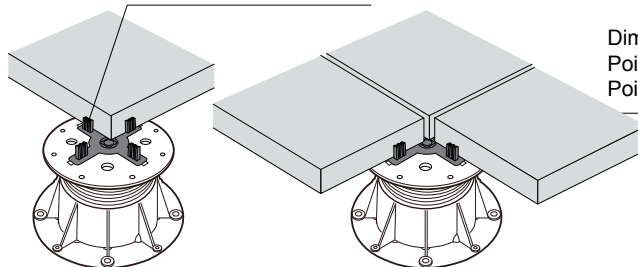

Dim. carton: **40x29x20**
Poids carton seul: **300g**
Poids carton + pces: **2kg**

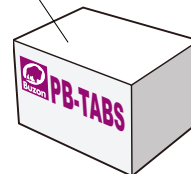

Code	Type
PB-CLIP-KIT-5	SIMPLE

Qté pces/carton
48

Single clip pour chevrons en bois de dimensions différentes



Poids: **40g**

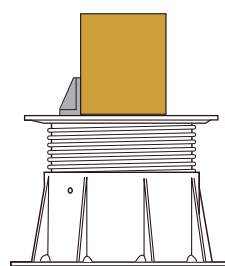
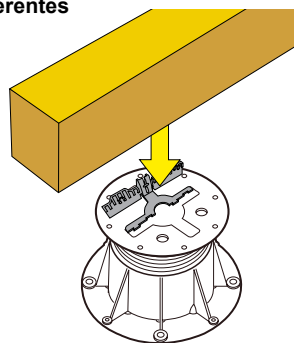
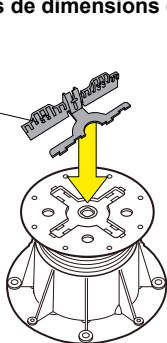

Dim. carton: **40x29x20**
Poids carton seul: **300g**
Poids carton + pces: **2.2Kg**



Code	Hauteur
BC-PH-5	12mm

Qté pces/carton
84

Correcteur de pente 0 to 5%



Poids **194g**

Remarque: Epaisseur = 12mm à ajouter aux plots réglables

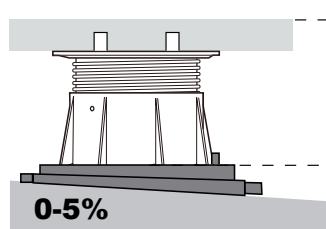
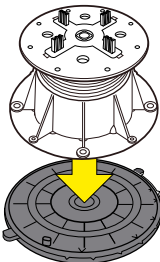

Dim. carton: **47x47x44**
Poids carton seul: **900g**
Poids carton + pces: **17kg**



Code	Epaisseur
BC-E10	1mm
BC-E20	2mm

Qté pces/carton
1mm: 500
2mm: 250

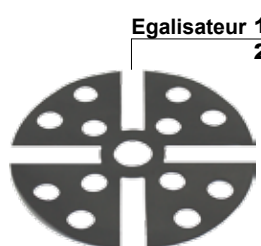

Poids: 1mm: **23gr**
2mm: **40gr**

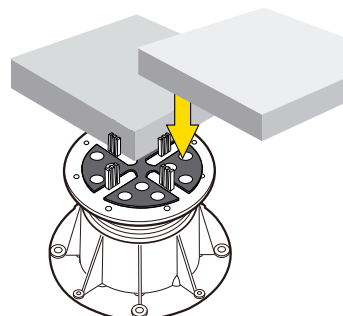
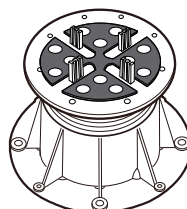
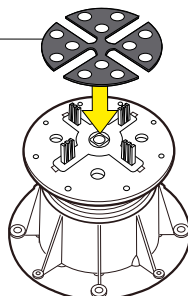

1mm
Dim. carton: **40x29x20**
Poids carton seul: **400g**
Poids carton + pces: **8kg**



2mm
Dim. carton: **40x29x20**
Poids carton seul: **400g**
Poids carton + pces: **8kg**



BUZON® PB-Serie

Accessoires

Vente à l'unité ou par carton complet

Code
PB-CLIP-KIT-1

Qté pces/carton
3240

Qté pces/sachet
120

Plug attache

Pour support dalles en bois



Fixation avec vis inox 4x35mm

Pour fixation de tuyaux

Poids: **2gr**

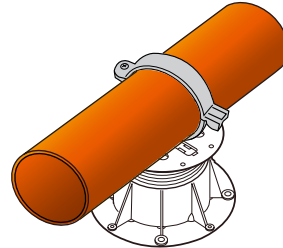
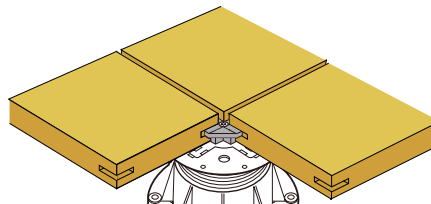
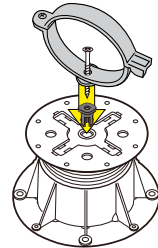
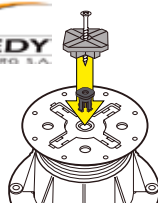

Dim. carton: **60x29x20**
Poids carton seul: **...g**
Poids carton + pces: **...g**



Code
PB-CLIP-KIT-2

Qté pces/carton
60

Clips pour lambourdes aluminium

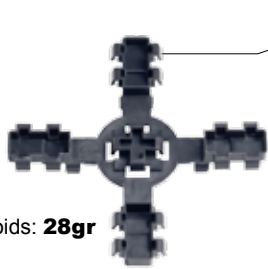

Poids: **28gr**

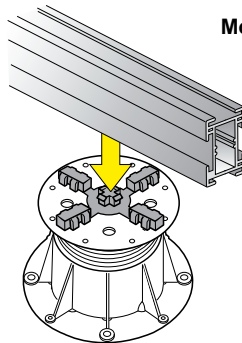
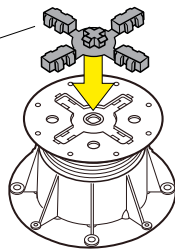

Modèle

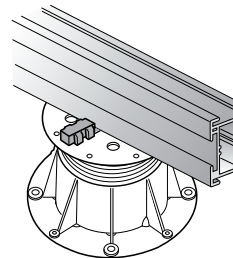

Dim. carton: **40x29x20**
Poids carton seul: **300g**
Poids carton + pces: **2kg**



Code
PB-CLIP-KIT-3

Type
Central

Qté pces/carton
72

Clip pour dalles



Pose centrale



Poids: **20gr**

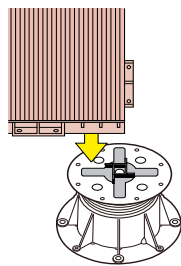
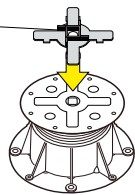

Dim. dalle: **439x439mm**

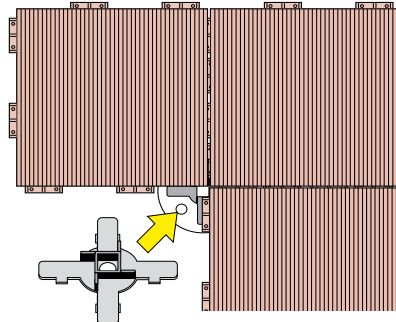

Dim. carton: **40x29x20**
Poids carton seul: **300g**
Poids carton + pces: **1.5kg**



Code
PB-CLIP-KIT-4

Type
EDGE WALL

Qté pces/carton
72

Clip for dalles



Pose en bord de mur



Poids: **19gr**

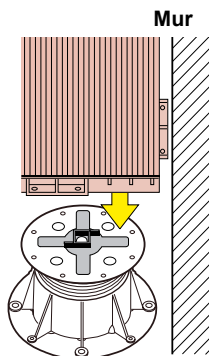
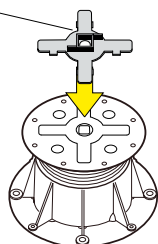

Dim. dalle: **439x439mm** Mur

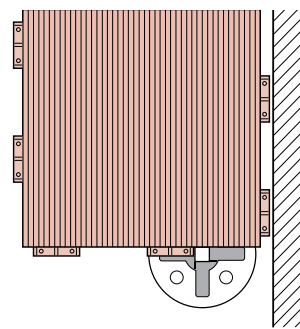

Dim. carton: **40x29x20**
Poids carton seul: **300g**
Poids carton + pces: **1.5kg**

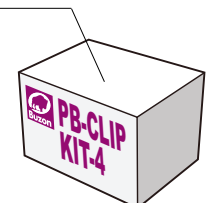

Vente à l'unité ou par carton complet

Code	Type
PB-CLIP-KIT-5	DOUBLE

Double clip pour chevrons en bois de dimension spécifique

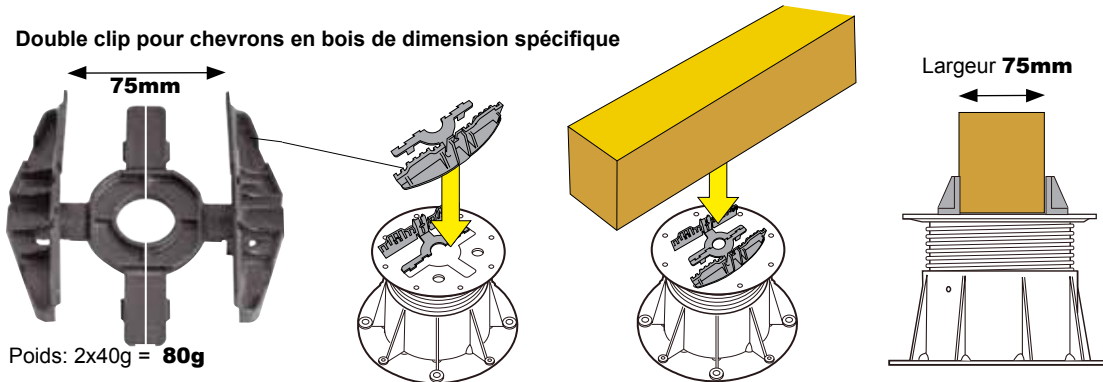

Poids: 2x40g = **80g**

Code	Type
BC-BATTEN-KIT-1	RACK PLUG LARGE

Qté pces/carton
120

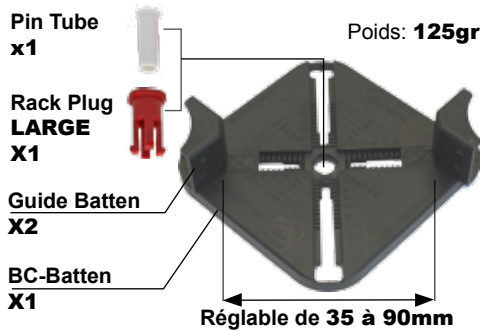

Poids: **125gr**

Pin Tube
x1

Rack Plug
LARGE
X1

Guide Batten
X2

BC-Batten
X1

Réglable de 35 à 90mm

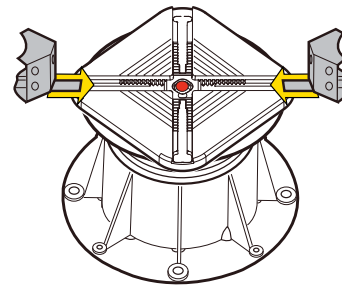

Dim. carton: **52x35x31**
Poids carton seul: **700g**
Poids carton + pces.: **16kg**



Remarque: Epaisseur du BC-BATTEN = 4mm à ajouter aux plots réglables

Code	Type
BC-GUIDE-BATTEN	Guide



2 guides supplémentaires
peuvent être ajoutés au
plateau BC-BATTEN
en cas d'utilisation avec
3 lambourdes

Poids: **12gr**

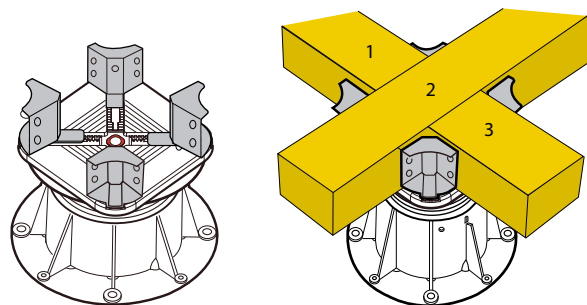

Code	Type
KIT-4-DPH	65mm

Items/carton
120

Poids: **96gr**



KIT-4
Rack Plug Large
h:25mm

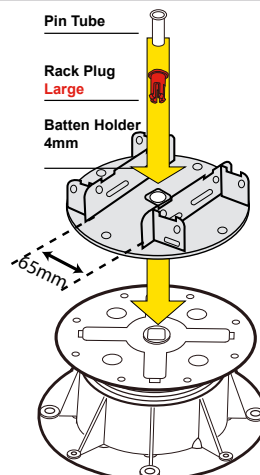

Dim. carton: **52x35x41**
Poids carton seul: **1000g**
Poids carton + pces.: **12kg**

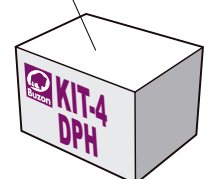

Vente à l'unité ou par carton complet

Code	Type
KEY-BC-DPH-PB	BPI

Qté pces/carton
1



Poids: **56 gr**

Clé en polyamide
pour un ajustage facile de
la hauteur des plots BUZON

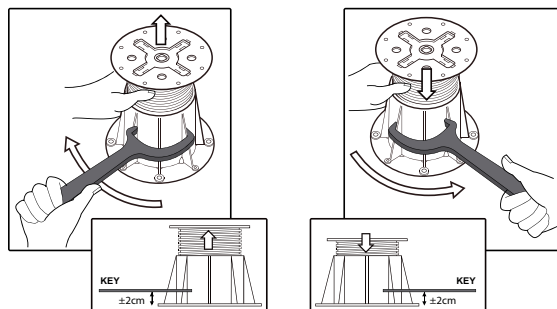

Code	Type
KIT SL 80	BPI

Qté pces/carton
1



Poids: **315 gr**

BUZON LEVEL Niveau à bulle
Détermine la valeur et la direction de la pente
à redresser (en %)

- Composition du Kit:
- Buzon Level
 - Plot BC-0
 - 4 clips de fixation
 - Craie
 - Instructions (AIP)

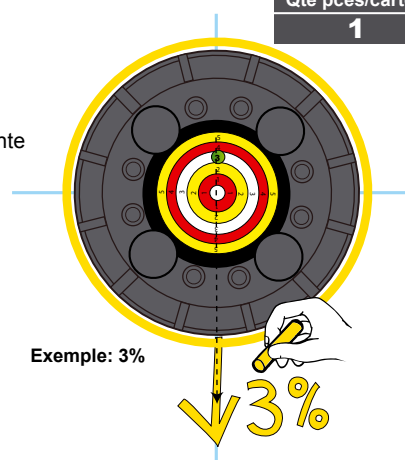

Exemple: 3%

Code	Type
GRIP LIFTING	BPI

Qté pces/carton
1



Poids: **1222 gr**

Dimensions des dalles en cm

30 x 30	35 x 35	40 x 40
45 x 45	49 x 49	50 x 50

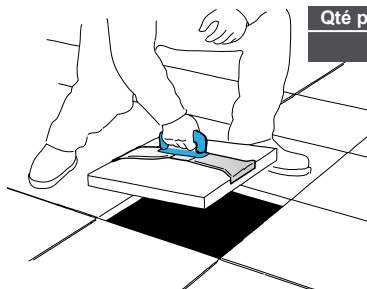



DES RÉFÉRENCES PARTOUT DANS LE MONDE



BUZON PB-Serie®



BUZON Pedestal International s.a./n.v
Z.I. des Hauts-Sarts, Zone 1 - Prolongement de la rue de l'Abbaye, 134 , B-4040 Herstal- Belgium
Tel +32(0)4 248 39 83 Fax +32(0)4 264 82 38 E-Mail info@buzon.eu www.buzon.eu